

# **CCIE Service Provider v3.0**

## **Sample Lab**

### **Part 7/7**

**Vincent Jun Ling Zhou**

**CCIE Service Provider – Product Manager**

**Cisco Systems**

# SP Sample Lab – Main Topology

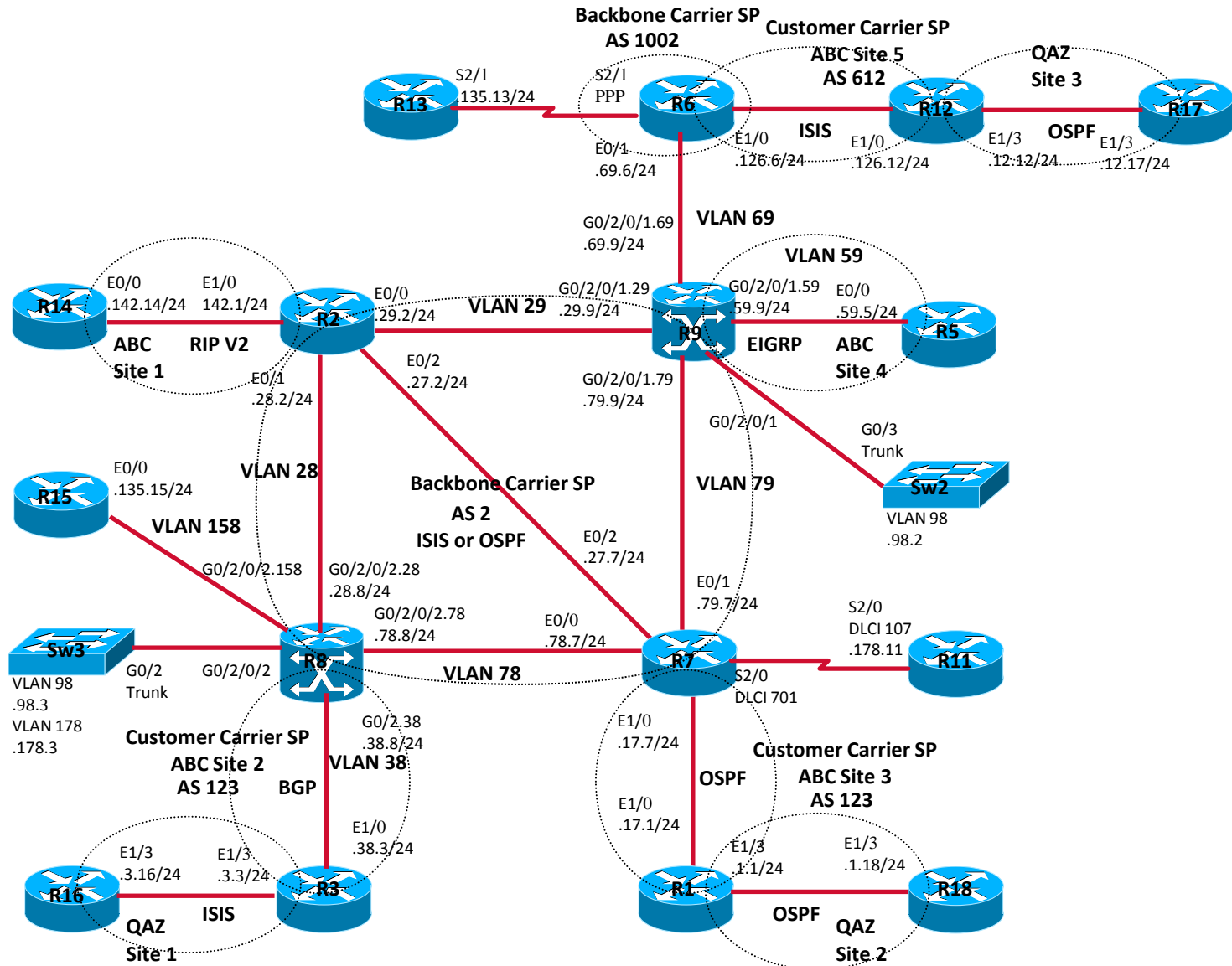

# SP Sample Lab – Addressing Scheme

- Backbone Carrier SP network Prefix: 2.2.0.0/24, 2002:2:2::/64
- Backbone Carrier SP router Loopback0: 2.2.0.Z/32, 2002:2:2::Z/128
- Customer Carrier SP/VPN network Prefix: 172.2.0.0/24, 2002:172:2::/64
- Customer Carrier SP/VPN router Loopback0: 172.2.0.Z/32, 2002:172:2::Z/128
- End Customer VPN network Prefix: 192.2.0.0/24
- End Customer VPN router Loopback0: 192.2.0.Z/32
- L2 VPN Customer network Prefix: 172.2.0.0/24
- L2 VPN Customer router Loopback0: 172.2.0.Z/32

“Z” is router number, for example “Z” value for R12 is “12”

# SP Sample Lab – Setup

- Hardware

  - Two XR-12404 with two GigabitEthernet interfaces or equivalent

  - Thirteen Cisco 7200 series routers with Ethernet interfaces or equivalent

  - Three Cisco 3560G series or equivalent

- Software Operating System

  - XR12000-iosxr-k9-3.9.1.tar

  - c7200-spservices-mz.122-33.SRE2.bin

  - c3560-advipservicesk9-mz.122-46.SE.bin

# SP Sample Lab Questions

	Question, Configuration and Verification
1	IS-IS IPv4/IPv6
2	OSPF IPv4/IPv6
3	BGP unicast IPv4/IPv6
4	MPLS LDP
5	MPLS TE
6	MPLS TE FRR
7	MP-BGP intra-AS VPNv4
8	MP-BGP inter-AS VPNv4
9	CSC
10	MP-BGP VPNv6 - 6VPE
11	Multicast VPN
12	AToM
13	VPLS
14	L2TPv3

# Any Transport over MPLS (AToM)

- AToM
  - Ethernet over MPLS
  - Frame Relay over MPLS
  - ATM AAL5 over MPLS
  - ATM Cell Relay over MPLS
  - PPP over MPLS
  - HDLC over MPLS
  - TDM over MPLS

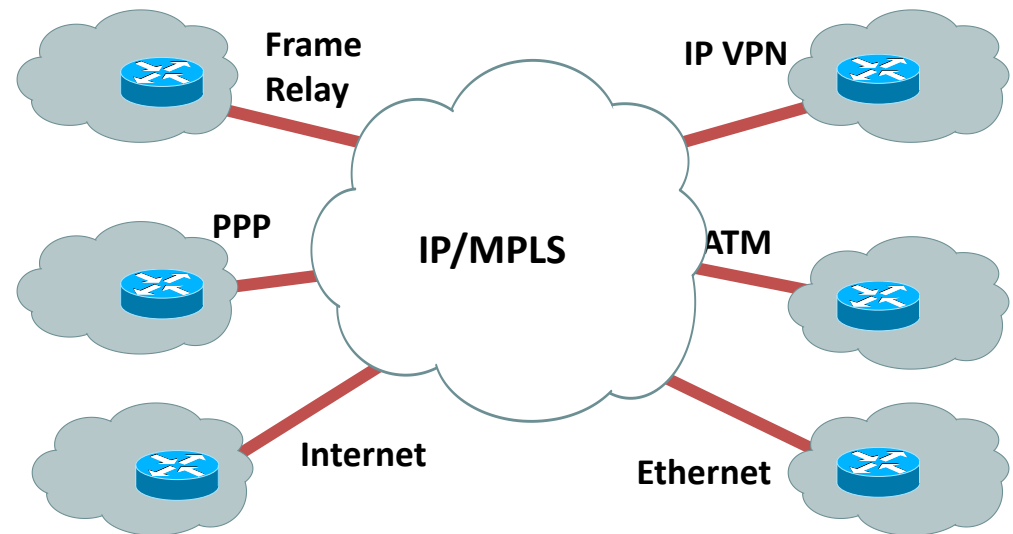

# Mapping to Lab Exam Blueprint

- This question of the sample lab maps to following sections/sub-sections in the Lab Exam Blueprint document below;

<https://learningnetwork.cisco.com/docs/DOC-9991>

4.0 – Implement, Optimize and Troubleshoot L2VPN Technologies

4.1 – Implement, Optimize and Troubleshoot AToM

- For more details, please review the Lab Exam Checklist document below;

<https://learningnetwork.cisco.com/docs/DOC-10145>

# AToM – Sub Topology and Question

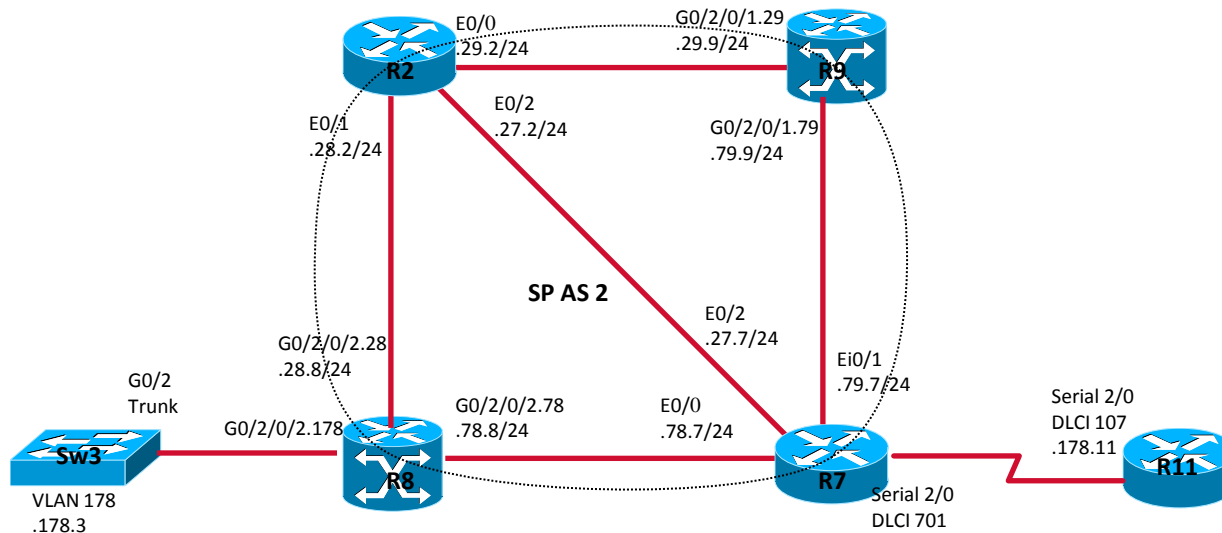

- Configure R7 and R8 to support VLAN and Frame-Relay interworking of AToM
- Ensure R11 and VLAN 178 can ping each other



# AToM Configuration

## R8 (IOS-XR) configuration

```
interface GigabitEthernet0/2/0/2.178 l2transport
dot1q vlan 178
!
l2vpn
pw-class atom
encapsulation mpls
!
!
xconnect group R8-R7
p2p abc
interface GigabitEthernet0/2/0/2.178
neighbor 2.2.0.7 pw-id 101
pw-class atom
!
interworking ipv4
!
!
```

## R7 (IOS) configuration

```
pseudowire-class atom
encapsulation mpls
interworking ip
!
interface Serial2/0
no ip address
encapsulation frame-relay
no frame-relay inverse-arp
frame-relay lmi-type ansi
!
connect abc Serial2/0 701 l2transport
xconnect 2.2.0.8 101 pw-class atom
!
!
```

# AToM Configuration (Cont.)

## Sw3 configuration

```
interface GigabitEthernet0/2
  switchport trunk encapsulation dot1q
  switchport mode trunk
  !
interface Vlan178
  ip address 172.2.178.3 255.255.255.0
  !
```

## R11 configuration

```
interface Serial2/0
  ip address 172.2.178.11 255.255.255.0
  encapsulation frame-relay
  no fair-queue
  serial restart-delay 0
  frame-relay map ip 172.2.178.3 107 broadcast
  no frame-relay inverse-arp
```

# AToM VC

## R8

```
RP/0/0/CPU0:R8#show l2vpn xconnect detail
Group R8-R7, XC abc, state is up; Interworking IPv4
AC: GigabitEthernet0/2/0/2.178, state is up
  Type VLAN; Num Ranges: 1
  VLAN ranges: [178, 178]
  MTU 1500; XC ID 0x3000004; interworking IPv4; MSTi 0
PW: neighbor 2.2.0.7, PW ID 101, state is up ( established )
  PW class atom, XC ID 0x3000004
  Encapsulation MPLS, protocol LDP
  PW type IP, control word enabled, interworking IPv4
  PW backup disable delay 0 sec
  Sequencing not set
  MPLS      Local              Remote
  -----
  Label     16011                    28
  Group ID  0x3000700                0x0
  Interface GigabitEthernet0/2/0/2.178  unknown
  MTU       1500                    1500
  Control word enabled                enabled
  PW type   IP                  IP
  VCCV CV type 0x2                    0x2
             (LSP ping verification)  (LSP ping verification)
  VCCV CC type 0x3                    0x3
             (control word)          (control word)
             (router alert label)    (router alert label)
  -----
```

# AToM VC (Cont.)

R7

R7#show mpls l2transport vc detail

Local interface: Se2/0 up, line protocol up, FR DLCI 701 up

MPLS VC type is FR DLCI, interworking type is IP

Destination address: 2.2.0.8, VC ID: 101, VC status: up

Output interface: Et0/0, imposed label stack {16011}

Preferred path: not configured

Default path: active

Next hop: 2.2.78.8

Create time: 1w0d, last status change time: 5d05h

Signaling protocol: LDP, peer 2.2.0.8:0 up

Targeted Hello: 2.2.0.7(LDP Id) -> 2.2.0.8

Status TLV support (local/remote) : enabled/not supported

Label/status state machine : established, LruRru

Last local dataplane status rcvd: no fault

Last local SSS circuit status rcvd: no fault

Last local SSS circuit status sent: no fault

Last local LDP TLV status sent: no fault

Last remote LDP TLV status rcvd: not sent

MPLS VC labels: local 28, remote 16011

Group ID: local 0, remote 50333440

MTU: local 1500, remote 1500

Remote interface description: GigabitEthernet0\_2\_0\_2.178

Sequencing: receive disabled, send disabled

# AToM MPLS forwarding table

RP/0/0/CPU0:R8#show mpls forwarding

Local Label	Outgoing Label	Prefix or ID	Outgoing Interface	Next Hop	Bytes Switched
16011	Pop	PW(2.2.0.7:101)	Gi0/2/0/2.178	point2point	6000

R7#show mpls forwarding-table

Local Label	Outgoing Label	Prefix or VC or Tunnel Id	Bytes Label Switched	Outgoing interface	Next Hop
28	No Label	I2ckt(101)	1500	Se2/0	point2point

# Pseudowire Ping Veification

```
R7#ping mpls pseudowire 2.2.0.8 101
```

```
Sending 5, 100-byte MPLS Echos to 2.2.0.8,  
  timeout is 2 seconds, send interval is 0 msec:
```

```
Codes: '!' - success, 'Q' - request not sent, '.' - timeout,  
'L' - labeled output interface, 'B' - unlabeled output interface,  
'D' - DS Map mismatch, 'F' - no FEC mapping, 'f' - FEC mismatch,  
'M' - malformed request, 'm' - unsupported tlvs, 'N' - no label entry,  
'P' - no rx intf label prot, 'p' - premature termination of LSP,  
'R' - transit router, 'I' - unknown upstream index,  
'X' - unknown return code, 'x' - return code 0
```

```
Type escape sequence to abort.
```

```
!!!!!
```

```
Success rate is 100 percent (5/5), round-trip min/avg/max = 280/291/300 ms
```

# Connection verification

R11#ping 172.2.178.3

Type escape sequence to abort.

Sending 5, 100-byte ICMP Echos to 172.2.178.3, timeout is 2 seconds:

!!!!

Success rate is 100 percent (5/5), round-trip min/avg/max = 48/50/52 ms

Sw3#ping 172.2.178.11

Type escape sequence to abort.

Sending 5, 100-byte ICMP Echos to 172.2.178.11, timeout is 2 seconds:

!!!!

Success rate is 100 percent (5/5), round-trip min/avg/max = 42/48/51 ms

# VPLS Components

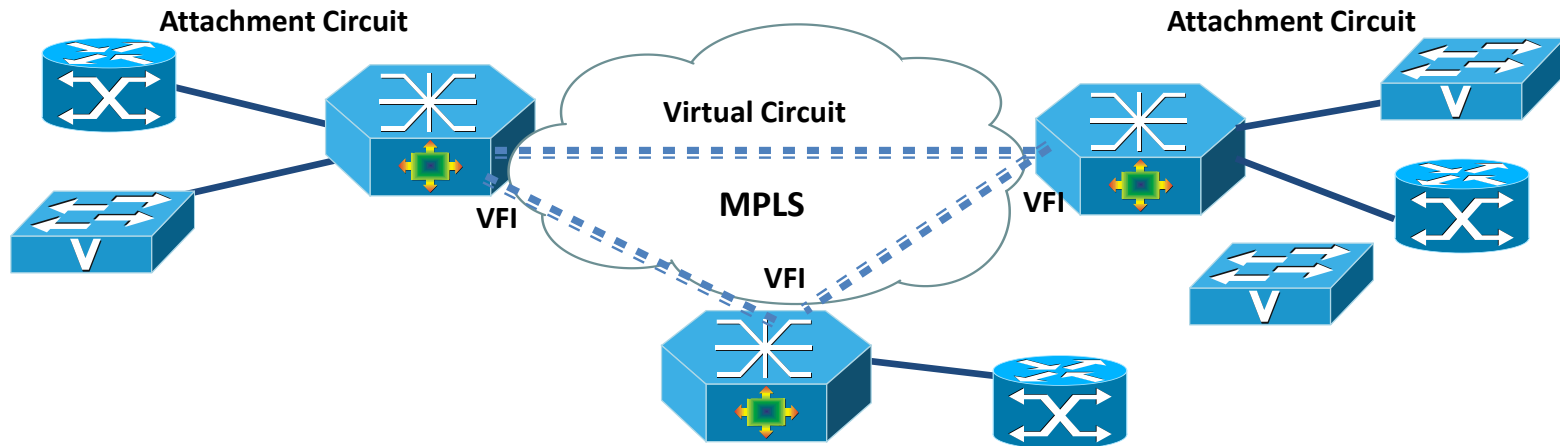

- **AC (Attachment Circuit)**
  - Connect to CE device, it could be Ethernet physical or logical port, ATM bridging (RFC-1483), FR bridging (RFC-1490), even AToM pseudo wire; one or multiple ACs can belong to same VFI
- **VC (Virtual Circuit)**
  - EoMPLS data encapsulation, tunnel label is used to reach remote PE, VC label is used to identify VFI; one or multiple VCs can belong to same VFI
- **VFI (Virtual Forwarding Instance)**
  - Also called VSI (Virtual Switching Instance); VFI create L2 multipoint bridging among all ACs and VCs; it's L2 broadcast domain like VLAN
  - Multiple VFI can exist on the same PE box to separate user traffic like VLAN



# Mapping to Lab Exam Blueprint

- This question of the sample lab maps to following sections/sub-sections in the Lab Exam Blueprint document below;

<https://learningnetwork.cisco.com/docs/DOC-9991>

4.0 – Implement, Optimize and Troubleshoot L2VPN Technologies

4.2 – Implement, Optimize and Troubleshoot VPLS and Carrier Ethernet

- For more details, please review the Lab Exam Checklist document below;

<https://learningnetwork.cisco.com/docs/DOC-10145>

# VPLS – Sub Topology and Question

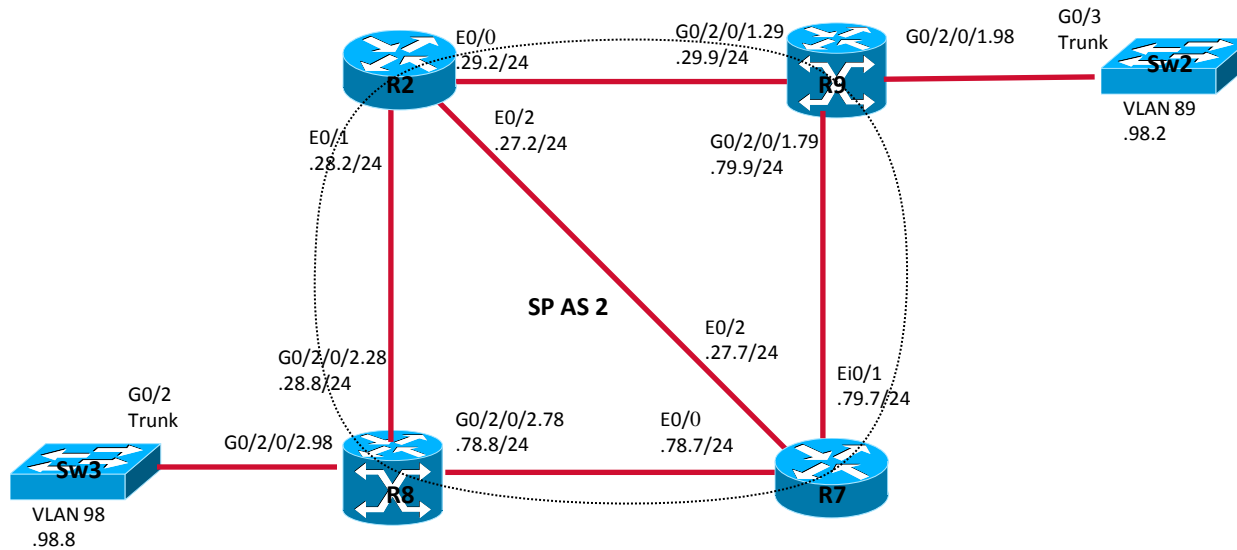

- Configure R8 and R9 to provide VPLS service to connect VLAN 98
- Change VLAN spanning tree priority on Sw2 so that Sw2 is root for VLAN 98

Note: VPLS on IOS-XR support only Bridge group mode on current version

# VPLS Configuration

## R8 (IOS-XR) configuration

```
interface GigabitEthernet0/2/0/2.98 l2transport
  dot1q vlan 98
!
l2vpn
  pw-class atom
  encapsulation mpls
!
!
bridge group vpls
  bridge-domain v98
  interface GigabitEthernet0/2/0/2.98
  !
  vfi 98
  neighbor 2.2.0.9 pw-id 908
  pw-class atom
!
```

## R9 (IOS-XR) configuration

```
interface GigabitEthernet0/2/0/1.98 l2transport
  dot1q vlan 98
!
l2vpn
  pw-class atom
  encapsulation mpls
!
!
bridge group vpls
  bridge-domain v98
  interface GigabitEthernet0/2/0/1.98
  !
  vfi 98
  neighbor 2.2.0.8 pw-id 908
  pw-class atom
!
```

# VPLS Configuration (Cont.)

## Sw3 configuration

```
spanning-tree mode pvst
spanning-tree extend system-id
!
vlan 98
!
interface GigabitEthernet0/2
switchport trunk encapsulation dot1q
switchport mode trunk
!
interface Vlan98
ip address 172.2.98.3 255.255.255.0
!
```

## Sw2 configuration

```
spanning-tree mode pvst
spanning-tree extend system-id
spanning-tree vlan 98 priority 20480
!
vlan 98
!
interface GigabitEthernet0/3
switchport trunk encapsulation dot1q
switchport mode trunk
!
interface Vlan98
ip address 172.2.98.2 255.255.255.0
!
```

# VPLS VC

## R8 VPLS VC

RP/0/0/CPU0:R8#show l2vpn bridge-domain detail

Bridge group: vpls, bridge-domain: v98, id: 1, state: up

MAC learning: enabled

MAC withdraw: disabled

Flooding:

Broadcast & Multicast: enabled

Unknown unicast: enabled

Security: disabled

DHCPv4 snooping: disabled

Bridge MTU: 1500

Filter MAC addresses:

ACs: 1 (1 up), VFIs: 1, PWs: 1 (1 up)

List of ACs:

AC: GigabitEthernet0/2/0/2.98, state is up

Type VLAN; Num Ranges: 1

VLAN ranges: [98, 98]

MTU 1500; XC ID 0x3000005; interworking none;

MAC learning: enabled

Flooding:

Broadcast & Multicast: enabled

Unknown unicast: enabled

MAC aging time: 300 s, Type: inactivity

MAC limit: 4000, Action: none, Notification: syslog

MAC limit reached: no

Security: disabled

DHCPv4 snooping: disabled

Static MAC addresses:

List of Access PWs:

List of VFIs:

VFI 98

PW: neighbor 2.2.0.9, PW ID 908, state is up ( established )

PW class atom, XC ID 0xff000003

Encapsulation MPLS, protocol LDP

PW type Ethernet, control word disabled, interworking none

PW backup disable delay 0 sec

Sequencing not set

MPLS	Local	Remote
Label	16017	16014
Group ID	0x1	0x1
Interface	98	98
MTU	1500	1500
Control word disabled		disabled
PW type	Ethernet	Ethernet
VCCV CV type 0x2		0x2
(LSP ping verification)		(LSP ping verification)
VCCV CC type 0x2		0x2
(router alert label)		(router alert label)

# VPLS VC (Cont.)

## R9 VPLS VC

RP/0/0/CPU0:R8#show l2vpn bridge-domain detail

Bridge group: vpls, bridge-domain: v98, id: 1, state: up

MAC learning: enabled

MAC withdraw: disabled

Flooding:

Broadcast & Multicast: enabled

Unknown unicast: enabled

Security: disabled

DHCPv4 snooping: disabled

Bridge MTU: 1500

Filter MAC addresses:

ACs: 1 (1 up), VFIs: 1, PWs: 1 (1 up)

List of ACs:

AC: GigabitEthernet0/2/0/1.98, state is up

Type VLAN; Num Ranges: 1

VLAN ranges: [98, 98]

MTU 1500; XC ID 0x3000004; interworking none;

MAC learning: enabled

Flooding:

Broadcast & Multicast: enabled

Unknown unicast: enabled

MAC aging time: 300 s, Type: inactivity

MAC limit: 4000, Action: none, Notification: syslog

MAC limit reached: no

Security: disabled

DHCPv4 snooping: disabled

Static MAC addresses:

List of Access PWs:

List of VFIs:

VFI 98

PW: neighbor 2.2.0.8, PW ID 908, state is up ( established )

PW class atom, XC ID 0xff000003

Encapsulation MPLS, protocol LDP

PW type Ethernet, control word disabled, interworking none

PW backup disable delay 0 sec

Sequencing not set

	MPLS	Local	Remote
Label	16014		16017
Group ID	0x1		0x1
Interface	98		98
MTU	1500		1500
Control word disabled			disabled
PW type	Ethernet		Ethernet
VCCV CV type 0x2			0x2
	(LSP ping verification)		(LSP ping verification)
VCCV CC type 0x2			0x2
	(router alert label)		(router alert label)

# MPLS forwarding table

RP/0/0/CPU0:R8#show mpls forwarding

Local Label	Outgoing Label	Prefix or ID	Outgoing Interface	Next Hop Switched	Bytes
16017	Pop	PW(2.2.0.9:908)	BD=1	point2point	0

RP/0/0/CPU0:R9#show mpls forwarding

Local Label	Outgoing Label	Prefix or ID	Outgoing Interface	Next Hop Switched	Bytes
16014	Pop	PW(2.2.0.8:908)	BD=1	point2point	0

# Pseudowire Ping

```
RP/0/0/CPU0:R8#ping mpls pseudowire 2.2.0.9 908
```

```
Sending 5, 100-byte MPLS Echos to 2.2.0.9 VC: 908,  
timeout is 2 seconds, send interval is 0 msec:
```

```
Codes: '!' - success, 'Q' - request not sent, '.' - timeout,  
'L' - labeled output interface, 'B' - unlabeled output interface,  
'D' - DS Map mismatch, 'F' - no FEC mapping, 'f' - FEC mismatch,  
'M' - malformed request, 'm' - unsupported tlvs, 'N' - no rx label,  
'P' - no rx intf label prot, 'p' - premature termination of LSP,  
'R' - transit router, 'I' - unknown upstream index,  
'X' - unknown return code, 'x' - return code 0
```

Type escape sequence to abort.

```
!!!!
```

```
Success rate is 100 percent (5/5), round-trip min/avg/max = 14/15/18 ms
```



# VPLS Connection verification

```
Sw3#show spanning-tree vlan 98
```

```
VLAN0098
```

```
Spanning tree enabled protocol ieee
```

```
Root ID Priority 20578
```

```
Address 0019.e758.4d00
```

```
Cost 4
```

```
Port 2 (GigabitEthernet0/2)
```

```
Hello Time 2 sec Max Age 20 sec Forward Delay 15 sec
```

```
Bridge ID Priority 32866 (priority 32768 sys-id-ext 98)
```

```
Address 0019.e758.4400
```

```
Hello Time 2 sec Max Age 20 sec Forward Delay 15 sec
```

```
Aging Time 300 sec
```

Interface	Role	Sts	Cost	Prio.	Nbr	Type
-----						
Gi0/2	Root	FWD	4	128.2	P2p	

```
Sw3#ping 172.2.98.2
```

```
Type escape sequence to abort.
```

```
Sending 5, 100-byte ICMP Echos to 172.2.98.2, timeout is 2 seconds:
```

```
!!!!
```

```
Success rate is 100 percent (5/5), round-trip min/avg/max = 16/20/26 ms
```

# VPLS Connection verification (Cont.)

Sw2#show spanning-tree vlan 98

VLAN0098

Spanning tree enabled protocol ieee

Root ID Priority 20578

Address 0019.e758.4d00

This bridge is the root

Hello Time 2 sec Max Age 20 sec Forward Delay 15 sec

Bridge ID Priority 20578 (priority 20480 sys-id-ext 98)

Address 0019.e758.4d00

Hello Time 2 sec Max Age 20 sec Forward Delay 15 sec

Aging Time 300 sec

Interface	Role	Sts	Cost	Prio.	Nbr	Type
-----						
Gi0/3	Desg	FWD	4	128.3	P2p	

Sw2#ping 172.2.98.3

Type escape sequence to abort.

Sending 5, 100-byte ICMP Echos to 172.2.98.3, timeout is 2 seconds:

!!!!

Success rate is 100 percent (5/5), round-trip min/avg/max = 17/20/25 ms

# L2TPv3 Architecture

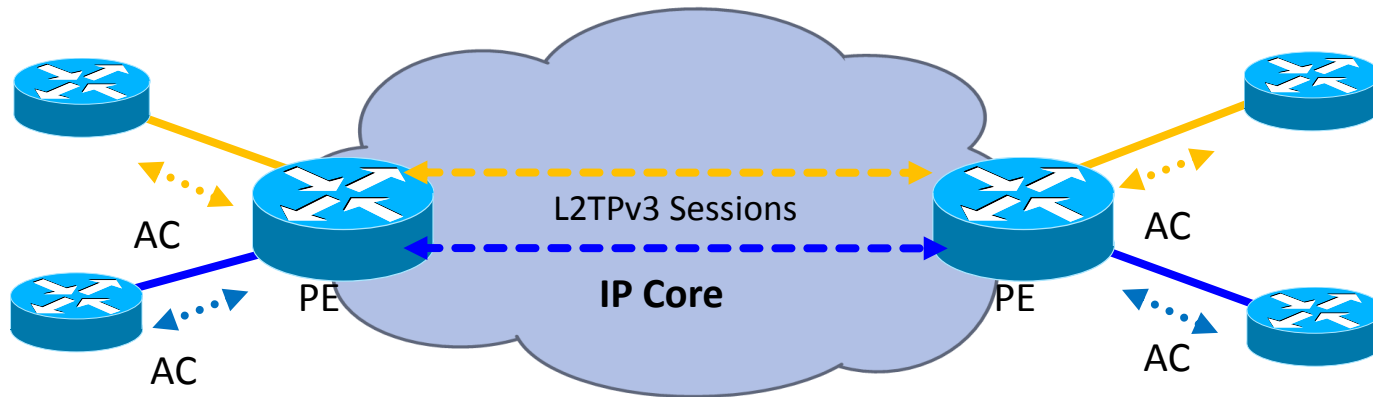

- The L2TPv3 Control Connection exists between two peers and is used for advertising and negotiating capabilities
- For each emulated pseudowire, L2TPv3 negotiates individual sessions

# Mapping to Lab Exam Blueprint

- This question of the sample lab maps to following sections/sub-sections in the Lab Exam Blueprint document below;

<https://learningnetwork.cisco.com/docs/DOC-9991>

4.0 – Implement, Optimize and Troubleshoot L2VPN Technologies

4.3 – Implement, Optimize and Troubleshoot L2TPv3 for L2 VPN

- For more details, please review the Lab Exam Checklist document below;

<https://learningnetwork.cisco.com/docs/DOC-10145>

# L2TPv3 – Sub Topology and Question

- Configure R6 and R8 to establish L2TPv3 session
- Configure L2TPv3 to support ip interworking
- Ensure VLAN 158 on R15 connect with PPP on R13 and they can ping each other

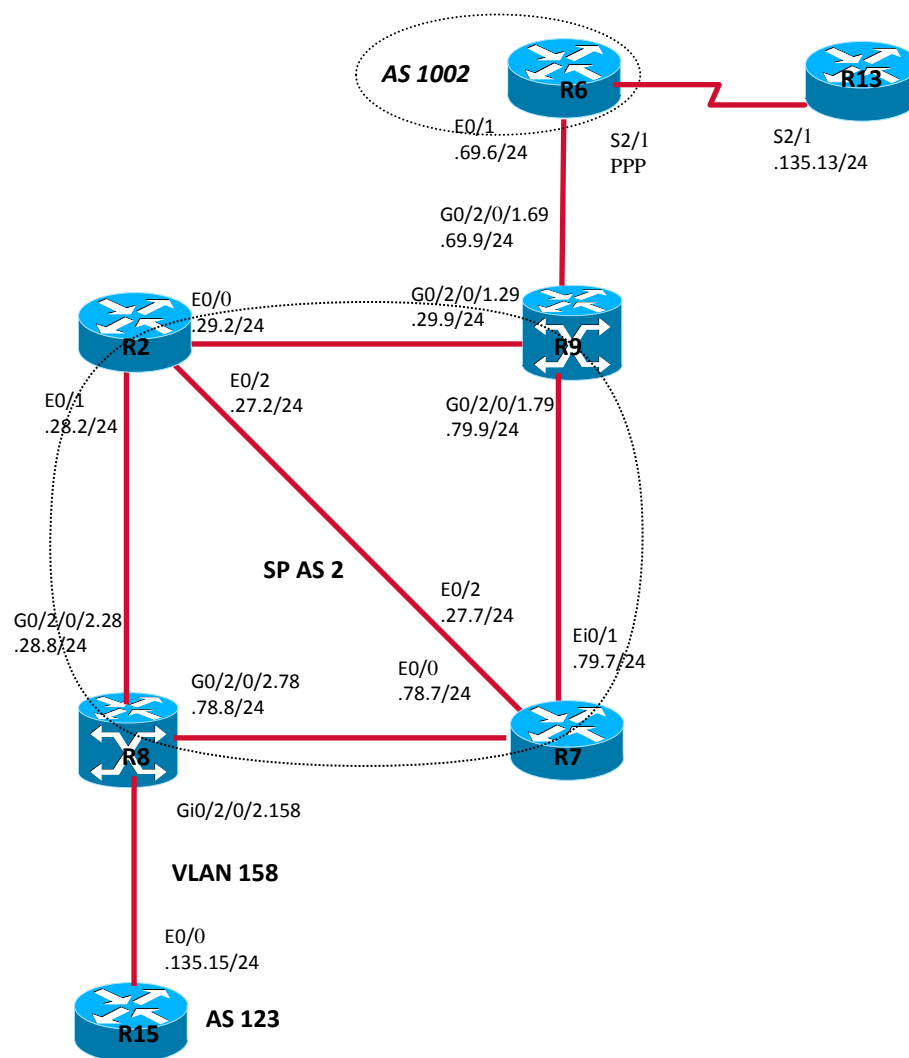

# L2TPv3 Configuration

## R8 (IOS-XR) configuration

```
interface GigabitEthernet0/2/0/2.158 l2transport
dot1q vlan 158
!
l2vpn
pw-class l2tp
encapsulation l2tpv3
protocol l2tpv3
ipv4 source 2.2.0.8
!
!
xconnect group efg
p2p efg
interface GigabitEthernet0/2/0/2.158
neighbor 2.2.0.6 pw-id 86
pw-class l2tp
!
interworking ipv4
!
!
```

## R6 (IOS) configuration

```
pseudowire-class l2tp
encapsulation l2tpv3
interworking ip
ip local interface Loopback0
!
interface Serial2/1
no ip address
encapsulation ppp
serial restart-delay 0
xconnect 2.2.0.8 86 pw-class l2tp
!
```

# L2TPv3 configuration (Cont.)

## R15 configuration

```
interface Ethernet0/0  
ip address 172.2.135.15 255.255.255.0  
!
```

## R13 configuration

```
interface Serial2/1  
ip address 172.2.135.13 255.255.255.0  
encapsulation ppp  
!
```

# L2TPv3 session

## R8 L2TPv3 session

RP/0/0/CPU0:R8#show l2tp session detail

Session id 32485 is up, tunnel id 3283985468, logical session id 32783

Remote session id is 2258215147, remote tunnel id 1879924250

Remotely initiated session

Call serial number is 30200001

Remote tunnel name is R6

Internet address is 2.2.0.6

Local tunnel name is R8

Internet address is 2.2.0.8

IP protocol 115

Session is L2TP signaled

Session state is established, time since change 1d06h

UDP checksums are disabled

1859145 Packets sent, 923702 received

215663860 Bytes sent, 93358423 received

Last clearing of counters 11w0d

Counters, ignoring last clear:

0 Packets sent, 0 received

0 Bytes sent, 0 received

Receive packets dropped:

out-of-order: 0

other: 0

total: 0

Send packets dropped:

exceeded session MTU: 0

other: 3261105

total: 3261105

Sequencing is off

Conditional debugging is disabled

Unique ID is 86

Session Layer 2 circuit

Payload type is IP, Name is GigabitEthernet0\_2\_0\_2.158

Session vcid is 86

Circuit state is UP

Local circuit state is UP

Remote circuit state is UP



# L2TPv3 session (Cont.)

## R6 L2TPv3 session

R6#show l2tp session all

Session id 2258215147 is up, tunnel id 1879924250

Remote session id is 32485, remote tunnel id  
3283985468

Locally initiated session

Unique ID is 4

Session Layer 2 circuit, type is PPP, name is Serial2/1

Session vcid is 86

L2TP VC type is IP, interworking type is IP

Circuit state is UP

Local circuit state is UP

Remote circuit state is UP

Call serial number is 30200001

Remote tunnel name is R8

Internet address is 2.2.0.8

Local tunnel name is R6

Internet address is 2.2.0.6

IP protocol 115

Session is L2TP signaled

Session state is established, time since change 1d06h

27250 Packets sent, 0 received

2335720 Bytes sent, 0 received

Last clearing of counters never

Counters, ignoring last clear:

27250 Packets sent, 0 received

2335720 Bytes sent, 0 received

DF bit off, ToS reflect disabled, ToS value 0, TTL value 255

UDP checksums are disabled

No session cookie information available

FS cached header information:

encap size = 24 bytes

45000014 00000000 FF73B767 02020004

02020008 00007EE5

Sequencing is off

Conditional debugging is disabled

# Connection verification

R13#ping 172.2.158.15

Type escape sequence to abort.

Sending 5, 100-byte ICMP Echos to 172.2.158.15, timeout is 2 seconds:

!!!!

Success rate is 100 percent (5/5), round-trip min/avg/max = 36/40/44 ms

R15#ping 172.2.158.13

Type escape sequence to abort.

Sending 5, 100-byte ICMP Echos to 172.2.158.13, timeout is 2 seconds:

!!!!

Success rate is 100 percent (5/5), round-trip min/avg/max = 36/40/44 ms



**CISCO**